

MCB

Miniature Circuit Breakers



Types

RI21N
RI50
RI70
RI100

Miniature circuit breakers of RI series are used for switching, conducting and switching off the current not only in normal operating conditions but also in special conditions in a circuit such as short circuit. They are used for overcurrent protection of house installations, industrial electric distributions and devices.

RI21N **6 kA**

Miniature Circuit Breakers

Applications

Miniature circuit breakers of RI series are used for switching, conducting and switching off the current not only in normal operating conditions but also in special conditions in a circuit such as short circuit. They are used for overcurrent protection of house installations, industrial electric distributions and devices.

Features

- ▶ Miniature circuit breaker RI21N is a device with protected line pole and switched neutral pole
- ▶ 1-pole + N in single housing
- ▶ Sealing possibility
- ▶ Indication of contacts state
- ▶ Mounting on the DIN rail and simple replacement

Standards

- ▶ IEC/EN 60898 -1



RI21N characteristics

Technical data	Symbol	Unit	RI21N
Standards			IEC/EN 60898 -1
Approvals			CE, KEMA
Number of poles			1 + N
Rated current	I_n	A	2, 3, 4, 5, 6, 10, 16, 20, 25, 32, 40, 50, 63
Tripping characteristics			B, C
Rated voltage	U_n	VAC	230/240
Rated frequency	f	Hz	50/60
Rated short circuit capacity	I_{cn}	kA	6
Rated impulse withstand voltage	U_{imp}	kV	4
Tightening torque		Nm	1.2
Terminals		mm ²	1 - 11
Ambient temperature		°C	-5 ... 55
Electrical endurance		op. c.	10.000
Mechanical endurance		op. c.	200.000
Mounting			35mm DIN rail acc. to EN 60715
Protection degree			IP20

Type	Rated Current I_n (A)	Rated Voltage U_n (V)	Number of Poles	Ordering No.	Weight (g)	Quantity / Box	Quantity / CTN
RI21 C type							
RI21N C2	2			786.100.529			
RI21N C4	4			786.100.522			
RI21N C6	6			786.100.523			
RI21N C10	10			786.100.510			
RI21N C16	16			786.100.511			
RI21N C20	20			786.100.512			
RI21N C25	25			786.100.524			
RI21N C32	32			786.100.525			
RI21N C40	40			786.100.531			
RI21 B type							
RI21N B2	2			786.100.528			
RI21N B4	4			786.100.518			
RI21N B6	6			786.100.519			
RI21N B10	10			786.100.513			
RI21N B16	16			786.100.514			
RI21N B20	20			786.100.515			
RI21N B25	25			786.100.520			
RI21N B32	32			786.100.521			
RI21N B40	40			786.100.530			
RI21 D type							
RI21N D20	20			786.100.532			



Tripping characteristics

Characteristics B acc. to EN 60 898

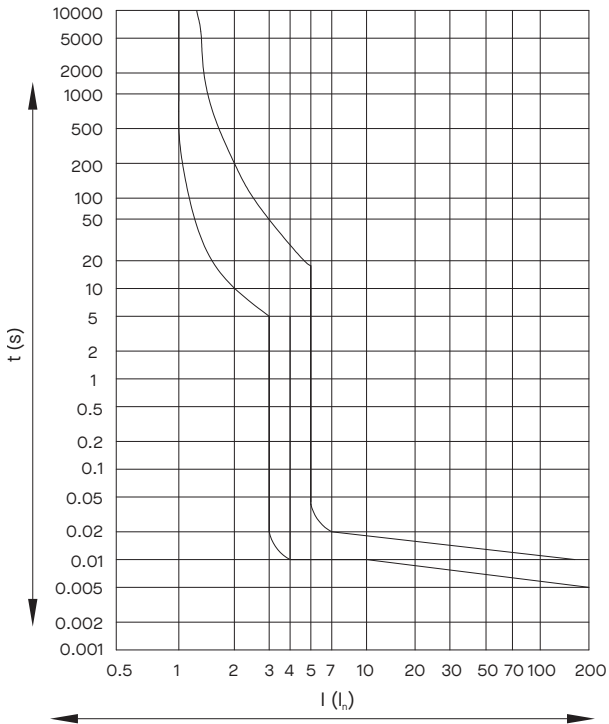

Characteristics C acc. to EN 60 898

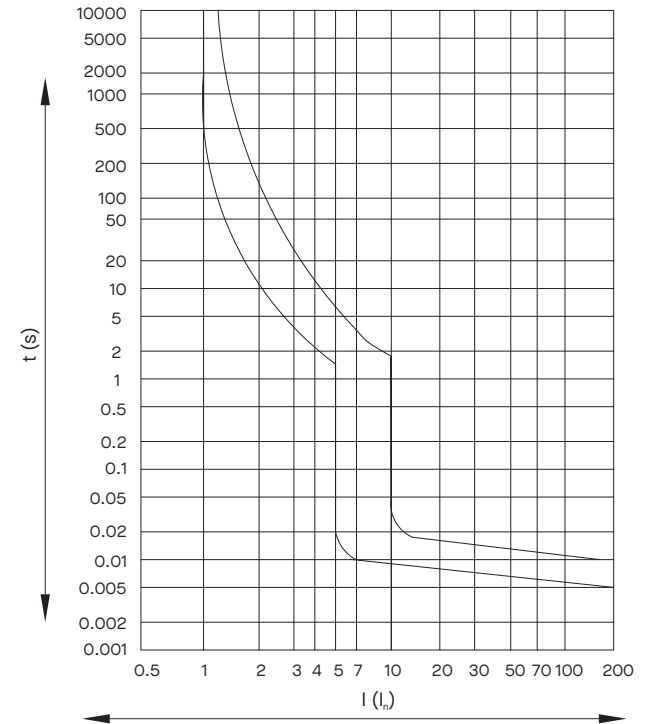

Dimensions

(mm)

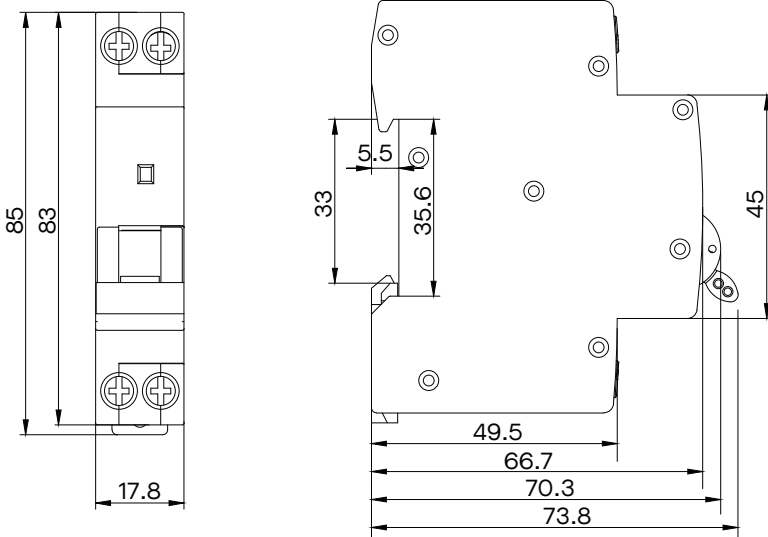

Wiring diagram

1P+N



RI50 6 kA

Miniature Circuit Breakers

Miniature circuit breakers of RI 50 series are used for the protection of installations and devices (overload and short circuit), and as a disconnecter in case of electric shock.



Types

RI 51	single pole
RI 51N	single pole + neutral pole
RI 52	two-pole
RI 53	three-pole
RI 53N	three-pole + neutral pole
RI 54	four pole

Benefits

- ▶ Due to the low permissible L2T (let through) values, smaller size of metal boxes can be used.
- ▶ Low let-through energy under short-circuit conditions ensures longer life of contacts and reduces thermal stresses in the distribution circuit.
- ▶ RI 50 reduces the energy loss due to a unique contact configuration and reduction of hot spots. Watt loss per pole for RI 50 is far lower than that specified in IEC/EN 60898.
- ▶ An optional operating position.
- ▶ IP20 degree of protection; IP40 degree of protection after installation in a distribution box.
- ▶ An additional colour indication of the position of main contacts (red: contacts closed — green: contacts open).

RI50 characteristics

Technical data	Symbol	Unit	RI50
Area of use			AC systems
Standards			IEC/EN 60898-1
Approvals			SEMKO, CE
Number of poles			1,1+N, 2, 3, 3+N, 4
Tripping characteristics			B, C
Rated current	I_n	A	6 ... 63
Rated voltage	U_n	V	240/415 (single-pole) 415 (multi-pole)
Rated DC voltage	U_n	V	60 (single-pole) 110 (multi-pole)
Max. time constant for DC voltage	t	ms	15/60 V DC max.
Rated impulse withstand voltage	U_{imp}	kV	4
Rated insulation voltage	U_i	V	500
Rated frequency	f	Hz	50/60
Rated short-circuit breaking capacity	I_{cu}, I_{cn}	kA	6
Service short-circuit breaking capacity	I_{cs}	kA	6
Selectivity class			3
Electrical endurance		op.c.	4 000
Mechanical endurance		op.c.	100 000
Terminal capacity		mm ²	up to 25
Screw type			M5
Screw head			PZ2
Tightening torque		Nm	2
Mounting			35 mm DIN rail acc. to EN 60715
Degree of protection			IP 20
Ambient temperature		°C	-25 ... 55
Altitude*		m	2 000
Mounting position			any
Resistance against vibrations			3 g (8 ... 50 Hz)
Accessories			Auxiliary contact PS50E-11 Shunt trip release VC50E Undervoltage release PC50E

RI50 – B characteristics

Type	Rated Current I_n (A)	Rated Voltage U_n (V)	Number of Poles	Ordering No.	Weight (g)	Quantity / Box	Quantity / CTN
RI51							
RI51 B6	6	240	1	786.091.006	100	12	120
RI51 B10	10	240	1	786.091.007	100	12	120
RI51 B16	16	240	1	786.091.008	100	12	120
RI51 B20	20	240	1	786.091.009	100	12	120
RI51 B25	25	240	1	786.091.010	100	12	120
RI51 B32	32	240	1	786.091.011	100	12	120
RI51 B40	40	240	1	786.091.012	100	12	120
RI51 B50	50	240	1	786.091.013	100	12	120
RI51 B63	63	240	1	786.091.014	100	12	120
RI51N							
RI51N B6	6	240/415	1+N	786.091.015	200	6	60
RI51N B10	10	240/415	1+N	786.091.016	200	6	60
RI51N B16	16	240/415	1+N	786.091.017	200	6	60
RI51N B20	20	240/415	1+N	786.091.018	200	6	60
RI51N B25	25	240/415	1+N	786.091.019	200	6	60
RI51N B32	32	240/415	1+N	786.091.020	200	6	60
RI51N B40	40	240/415	1+N	786.091.021	200	6	60
RI51N B50	50	240/415	1+N	786.091.022	200	6	60
RI51N B63	63	240/415	1+N	786.091.023	200	6	60
RI52							
RI52 B6	6	240/415	2	786.091.024	200	6	60
RI52 B10	10	240/415	2	786.091.025	200	6	60
RI52 B16	16	240/415	2	786.091.026	200	6	60
RI52 B20	20	240/415	2	786.091.027	200	6	60
RI52 B25	25	240/415	2	786.091.028	200	6	60
RI52 B32	32	240/415	2	786.091.029	200	6	60
RI52 B40	40	240/415	2	786.091.030	200	6	60
RI52 B50	50	240/415	2	786.091.031	200	6	60
RI52 B63	63	240/415	2	786.091.032	200	6	60
RI53							
RI53 B6	6	415	3	786.091.033	300	4	40
RI53 B10	10	415	3	786.091.034	300	4	40
RI53 B16	16	415	3	786.091.035	300	4	40
RI53 B20	20	415	3	786.091.036	300	4	40
RI53 B25	25	415	3	786.091.037	300	4	40
RI53 B32	32	415	3	786.091.038	300	4	40
RI53 B40	40	415	3	786.091.039	300	4	40
RI53 B50	50	415	3	786.091.040	300	4	40
RI53 B63	63	415	3	786.091.041	300	4	40
RI53N							
RI53N B6	6	415	3+N	786.091.042	400	3	30
RI53N B10	10	415	3+N	786.091.043	400	3	30
RI53N B16	16	415	3+N	786.091.044	400	3	30
RI53N B20	20	415	3+N	786.091.045	400	3	30
RI53N B25	25	415	3+N	786.091.046	400	3	30
RI53N B32	32	415	3+N	786.091.047	400	3	30
RI53N B40	40	415	3+N	786.091.048	400	3	30
RI53N B50	50	415	3+N	786.091.049	400	3	30
RI53N B63	63	415	3+N	786.091.050	400	3	30
RI54							
RI54 B6	6	415	4	786.091.051	400	3	30
RI54 B10	10	415	4	786.091.052	400	3	30
RI54 B16	16	415	4	786.091.053	400	3	30
RI54 B20	20	415	4	786.091.054	400	3	30
RI54 B25	25	415	4	786.091.055	400	3	30
RI54 B32	32	415	4	786.091.056	400	3	30
RI54 B40	40	415	4	786.091.057	400	3	30
RI54 B50	50	415	4	786.091.058	400	3	30
RI54 B63	63	415	4	786.091.059	400	3	30



RI50 – C characteristics

Type	Rated Current I_n (A)	Rated Voltage U_n (V)	No. of Poles	Ordering No.	Weight (g)	Quantity / Box	Quantity / CTN
RI51							
RI51 C6	6	240	1	786.091.100	100	12	
RI51 C16	16	240	1	786.091.102	100	12	
RI51 C10	10	240	1	786.091.101	100	12	
RI51 C20	20	240	1	786.091.103	100	12	
RI51 C25	25	240	1	786.091.104	100	12	
RI51 C32	32	240	1	786.091.105	100	12	
RI51 C40	40	240	1	786.091.106	100	12	
RI51 C50	50	240	1	786.091.107	100	12	
RI51 C63	63	240	1	786.091.108	100	12	



RI51N							
RI51N C6	6	240/415	1 + N	786.091.109	200	6	
RI51N C16	16	240/415	1 + N	786.091.111	200	6	
RI51N C10	10	240/415	1 + N	786.091.110	200	6	
RI51N C20	20	240/415	1 + N	786.091.112	200	6	
RI51N C25	25	240/415	1 + N	786.091.113	200	6	
RI51N C32	32	240/415	1 + N	786.091.114	200	6	
RI51N C40	40	240/415	1 + N	786.091.115	200	6	
RI51N C50	50	240/415	1 + N	786.091.116	200	6	
RI51N C63	63	240/415	1 + N	786.091.117	200	6	



RI52							
RI52 C6	6	240/415	2	786.091.118	200	6	
RI52 C16	16	240/415	2	786.091.120	200	6	
RI52 C10	10	240/415	2	786.091.119	200	6	
RI52 C20	20	240/415	2	786.091.121	200	6	
RI52 C25	25	240/415	2	786.091.122	200	6	
RI52 C32	32	240/415	2	786.091.123	200	6	
RI52 C40	40	240/415	2	786.091.124	200	6	
RI52 C50	50	240/415	2	786.091.125	200	6	
RI52 C63	63	240/415	2	786.091.126	200	6	



RI53							
RI53 C6	6	415	3	786.091.127	300	4	
RI53 C16	16	415	3	786.091.129	300	4	
RI53 C10	10	415	3	786.091.128	300	4	
RI53 C20	20	415	3	786.091.130	300	4	
RI53 C25	25	415	3	786.091.131	300	4	
RI53 C32	32	415	3	786.091.132	300	4	
RI53 C40	40	415	3	786.091.133	300	4	
RI53 C50	50	415	3	786.091.134	300	4	
RI53 C63	63	415	3	786.091.135	300	4	



RI50 – C characteristics

Type	Rated Current I_n (A)	Rated Voltage U_n (V)	No. of Poles	Ordering No.	Weight (g)	Quantity / Box	Quantity / CTN
RI53N							
RI53N C6	6	415	3 + N	786.091.136	400	3	
RI53N C16	16	415	3 + N	786.091.138	400	3	
RI53N C10	10	415	3 + N	786.091.137	400	3	
RI53N C20	20	415	3 + N	786.091.139	400	3	
RI53N C25	25	415	3 + N	786.091.140	400	3	
RI53N C32	32	415	3 + N	786.091.141	400	3	
RI53N C40	40	415	3 + N	786.091.142	400	3	
RI53N C50	50	415	3 + N	786.091.143	400	3	
RI53N C63	63	415	3 + N	786.091.144	400	3	
RI54							
RI54 C6	6	415	4	786.091.145	400	3	
RI54 C16	16	415	4	786.091.147	400	3	
RI54 C10	10	415	4	786.091.146	400	3	
RI54 C20	20	415	4	786.091.148	400	3	
RI54 C25	25	415	4	786.091.149	400	3	
RI54 C32	32	415	4	786.091.150	400	3	
RI54 C40	40	415	4	786.091.151	400	3	
RI54 C50	50	415	4	786.091.152	400	3	
RI54 C63	63	415	4	786.091.153	400	3	



Accessories for RI50

Auxiliary contacts

Type	Ordering No.	Weight (g)	Quantity / Box	Quantity / CTN
PS50E-11	786.091.154	42	1	

Shunt trip release

Type	Control voltages U_c (V)	Ordering No.	Weight (g)	Quantity / Box	Quantity / CTN
VC50E 230	230	786.091.155	82	1	

Undervoltage release

Type	Control voltages U_c (V)	Ordering No.	Weight (g)	Quantity / Box	Quantity / CTN
PC50E 230	110 - 415	786.091.156	78	1	



Auxiliary contact block

Technical data	Symbol	Unit	PS50E-11
Standards			IEC/EN 60947-5-1
Number of contacts			1 change-over *
Rated operational voltage	U_e	V	230
Rated insulation voltage	U_i	V	400
Rated frequency	f	Hz	50/60
Rated thermal current	I_{th}	A	6
Rated operational current	I_e	V	AC-15: 230 V / 4 A DC-13: 110 V / 0.4
Rated conditional short-circuit current		A	800
Fuse gG		A	6
Mounting			on left side of device
Degree of protection			IP 20
Terminal capacity	S	mm ²	0.5 ... 2.5 (Cu wire)
Screw type	I_{cs}	A	M2.5
Screw head			PZ2
Tightening torque		Nm	1

* Change-over contacts indicate the position of main contacts of circuit breaker

Undervoltage release

Technical data	Symbol	Unit	PC50E
Standards			IEC/EN 60947-1
Rated voltage	U_e	V	230
Rated frequency	f	Hz	50
Power consumption	P	W	3
Mounting			on right side of device
Degree of protection			IP 20
Terminal capacity	S	mm ²	0.5 ... 2.5 (Cu wire)
Screw type	I_{cs}	A	M5
Screw head			PZ2
Tightening torque		Nm	2
Operating limits			Pick-up voltage: 85% U_n Drop-out voltage: 35% U_n

Shunt release

Technical data	Symbol	Unit	VC50E
Standards			IEC/EN 60947-1
Rated voltage	U_n	V	230*
Rated impulse withstand voltage	U_{imp}	kV	4
Rated making overvoltage		kV	4
Rated frequency	f	Hz	50/60
Max. switching off current (voltage of VC)		A (V)	0.9 (125); 0.6 (230); 0.3 (400)
Mounting			on right side of circuit breaker (switch)
Degree of protection			IP 20
Terminal capacity	S	mm ²	1.5 ... 6
Screw type			M5
Screw head			PZ2
Tightening torque		Nm	2.5
Operating limits			70 ... 110 % U_n
Tripping time		ms	max. 50

* Other rated voltage of AC and DC on request

Tripping characteristics

Characteristics B acc. to EN 60 898

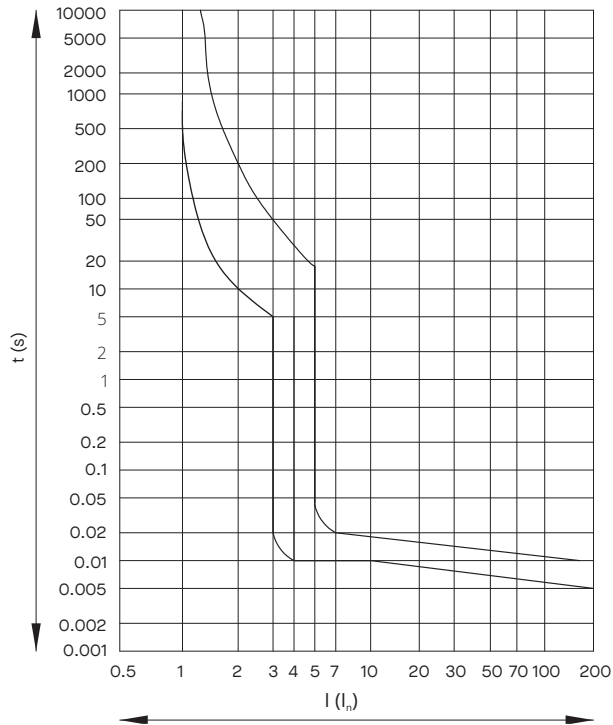

Characteristics C acc. to EN 60 898

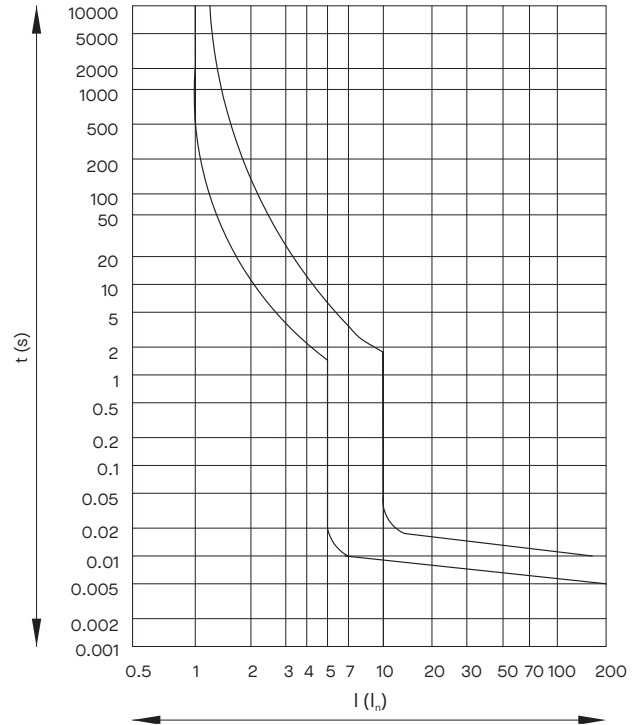

Dimensions

(mm)

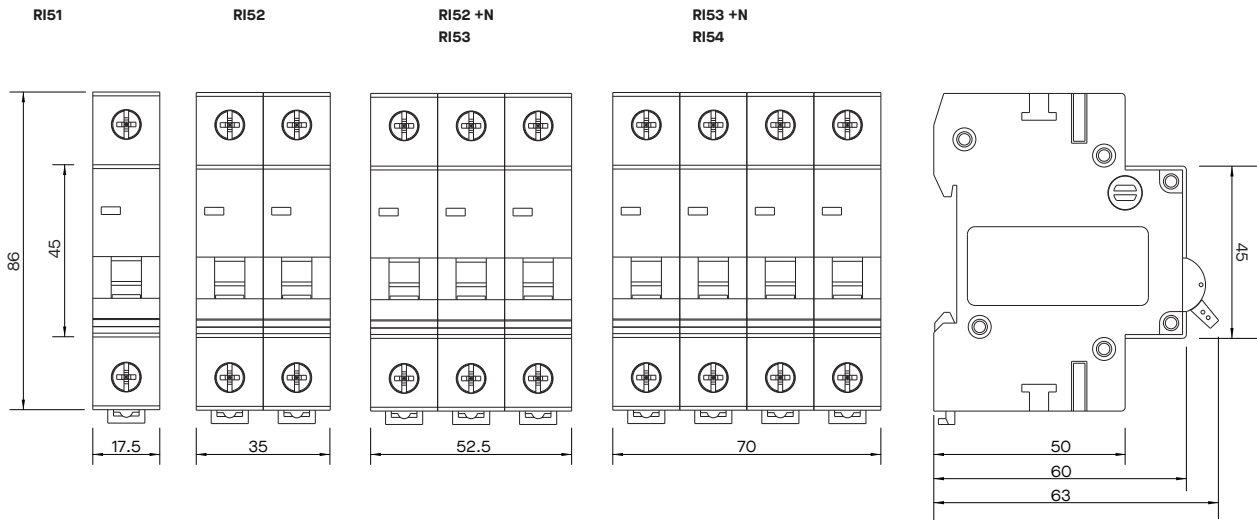

AUXILIARY CONTACT PS50E-11

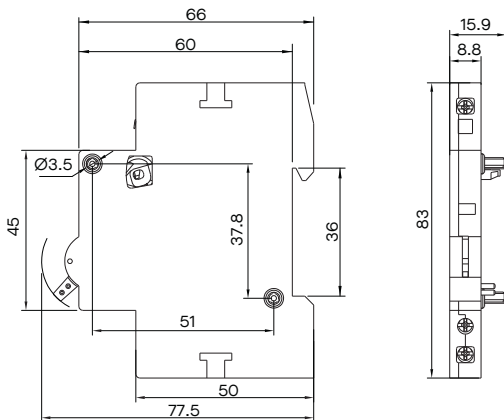

SHUNT TRIP RELEASE VC50E

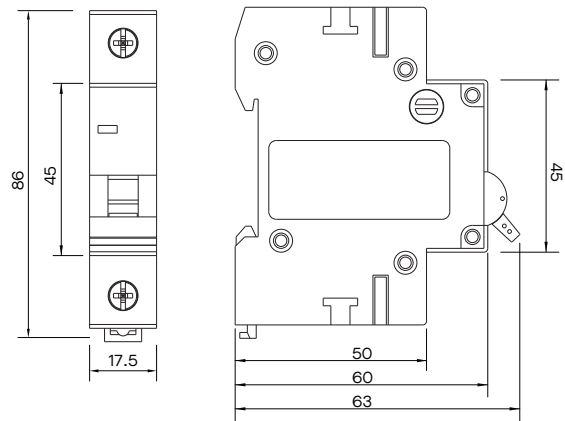

UNDERVOLTAGE RELEASE PC50E

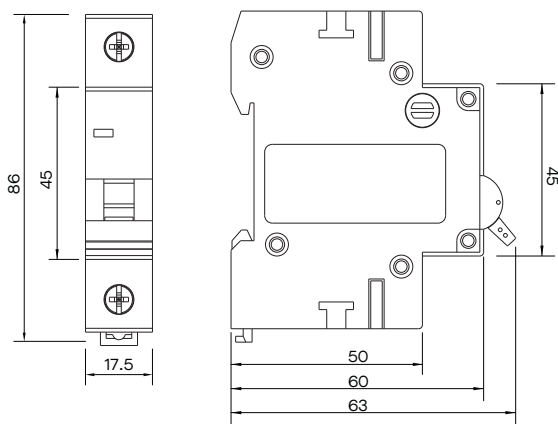

RI70

Miniature Circuit Breakers

Types

RI71	single pole
RI72	two pole
RI73	three pole
RI74	four pole
RI71N	single pole + neutral pole
RI73N	three pole + neutral pole



Benefits

- ▶ Protection against both overload and short circuit, function of isolation
- ▶ High short circuit capacity: $I_{cn} = I_{cs} = 10 \text{ kA}$ with Energy Limiting Class 3
- ▶ Contact position indicator
- ▶ 35 mm DIN rail mounting and screw mounting
- ▶ Full range accessories are available



Technical data	Symbol	Unit	RI70
Standards			IEC/EN 60898-1
Rated current	I_n	A	0.5, 1, 2, 3, 4, 6, 8, 10, 13, 16, 20, 25, 32, 40, 50, 63
Rated voltage	U_n	V	AC 230/240, AC 400/415
Breaking capacity		kA	$I_{cn} = I_{cs} = 10$
Rated frequency	f_n	Hz	50/60
Tripping characteristics			B, C, D
Number of poles			1P, 2P, 3P, 4P, 1P+N, 3P+N
Rated impulse withstand voltage	U_{imp}	kV	4
Electrical endurance			10000 cycles
Mechanical endurance			20000 cycles
Terminal			pillar type
Cable termination		mm ²	25
Torque of screw		Nm	2.5
IP degree			IP20

RI70 — C characteristics

Type	Rated Current I_n (A)	Rated Voltage U_n (V)	No. of Poles	Ordering No.	Weight (g)	Quantity / Box	Quantity / CTN
RI71							
RI71 C0.5	0.5	230/240	1	786.091.483	100	12	120
RI71 C1	1	230/240	1	786.091.182	105	12	120
RI71 C2	2	230/240	1	786.091.183	102	12	120
RI71 C3	3	230/240	1	786.091.184	104	12	120
RI71 C4	4	230/240	1	786.091.185	104	12	120
RI71 C6	6	230/240	1	786.091.186	104	12	120
RI71 C8	8	230/240	1	786.091.187	105	12	120
RI71 C10	10	230/240	1	786.091.188	105	12	120
RI71 C13	13	230/240	1	786.091.189	104	12	120
RI71 C16	16	230/240	1	786.091.190	104	12	120
RI71 C20	20	230/240	1	786.091.191	105	12	120
RI71 C25	25	230/240	1	786.091.192	105	12	120
RI71 C32	32	230/240	1	786.091.193	105	12	120
RI71 C40	40	230/240	1	786.091.194	110	12	120
RI71 C50	50	230/240	1	786.091.195	117	12	120
RI71 C63	63	230/240	1	786.091.196	123	12	120
RI72							
RI72 C0.5	0.5	415	2	786.091.492	200	6	60
RI72 C1	1	415	2	786.091.197	210	6	60
RI72 C2	2	415	2	786.091.198	220	6	60
RI72 C3	3	415	2	786.091.199	220	6	60
RI72 C4	4	415	2	786.091.200	220	6	60
RI72 C6	6	415	2	786.091.201	225	6	60
RI72 C8	8	415	2	786.091.202	226	6	60
RI72 C10	10	415	2	786.091.203	226	6	60
RI72 C13	13	415	2	786.091.204	226	6	60
RI72 C16	16	415	2	786.091.205	225	6	60
RI72 C20	20	415	2	786.091.206	226	6	60
RI72 C25	25	415	2	786.091.207	226	6	60
RI72 C32	32	415	2	786.091.208	226	6	60
RI72 C40	40	415	2	786.091.209	235	6	60
RI72 C50	50	415	2	786.091.210	235	6	60
RI72 C63	63	415	2	786.091.211	246	6	60
RI73							
RI73 C0.5	0.5	415	3	786.091.493	300	4	40
RI73 C1	1	415	3	786.091.212	315	4	40
RI73 C2	2	415	3	786.091.213	306	4	40
RI73 C3	3	415	3	786.091.214	312	4	40
RI73 C4	4	415	3	786.091.215	312	4	40
RI73 C6	6	415	3	786.091.216	312	4	40
RI73 C8	8	415	3	786.091.187	312	4	40
RI73 C10	10	415	3	786.091.218	312	4	40
RI73 C13	13	415	3	786.091.189	312	4	40
RI73 C16	16	415	3	786.091.220	312	4	40
RI73 C20	20	415	3	786.091.221	315	4	40
RI73 C25	25	415	3	786.091.222	315	4	40
RI73 C32	32	415	3	786.091.223	315	4	40
RI73 C40	40	415	3	786.091.224	330	4	40
RI73 C50	50	415	3	786.091.225	351	4	40
RI73 C63	63	415	3	786.091.226	367	4	40



RI70 — C characteristics

Type	Rated Current I_n (A)	Rated Voltage U_n (V)	No. of Poles	Ordering No.	Weight (g)	Quantity / Box	Quantity / CTN
RI74							
RI74 C0.5	0.5	415	4	786.091.494	400	3	30
RI74 C1	1	415	4	786.091.227	420	3	30
RI74 C2	2	415	4	786.091.228	424	3	30
RI74 C3	3	415	4	786.091.229	432	3	30
RI74 C4	4	415	4	786.091.230	432	3	30
RI74 C6	6	415	4	786.091.231	432	3	30
RI74 C8	8	415	4	786.091.232	432	3	30
RI74 C10	10	415	4	786.091.233	432	3	30
RI74 C13	13	415	4	786.091.234	432	3	30
RI74 C16	16	415	4	786.091.235	448	3	30
RI74 C20	20	415	4	786.091.236	448	3	30
RI74 C25	25	415	4	786.091.237	448	3	30
RI74 C32	32	415	4	786.091.238	447	3	30
RI74 C40	40	415	4	786.091.239	448	3	30
RI74 C50	50	415	4	786.091.240	468	3	30
RI74 C63	63	415	4	786.091.241	489	3	30
RI71N							
RI71N C0.5	0.5	230/240	1+N	786.091.500	199	6	60
RI71N C1	1	230/240	1+N	786.091.242	204	6	60
RI71N C2	2	230/240	1+N	786.091.243	201	6	60
RI71N C3	3	230/240	1+N	786.091.244	203	6	60
RI71N C4	4	230/240	1+N	786.091.245	203	6	60
RI71N C6	6	230/240	1+N	786.091.246	203	6	60
RI71N C8	8	230/240	1+N	786.091.247	204	6	60
RI71N C10	10	230/240	1+N	786.091.248	204	6	60
RI71N C13	13	230/240	1+N	786.091.249	203	6	60
RI71N C16	16	230/240	1+N	786.091.250	203	6	60
RI71N C20	20	230/240	1+N	786.091.251	204	6	60
RI71N C25	25	230/240	1+N	786.091.252	204	6	60
RI71N C32	32	230/240	1+N	786.091.253	204	6	60
RI71N C40	40	230/240	1+N	786.091.254	209	6	60
RI71N C50	50	230/240	1+N	786.091.255	216	6	60
RI71N C63	63	230/240	1+N	786.091.256	222	6	60
RI73N							
RI73N C0.5	0.5	415	3+N	786.091.502	400	3	30
RI73N C1	1	415	3+N	786.091.257	414	3	30
RI73N C2	2	415	3+N	786.091.258	405	3	30
RI73N C3	3	415	3+N	786.091.259	411	3	30
RI73N C4	4	415	3+N	786.091.260	411	3	30
RI73N C6	6	415	3+N	786.091.261	411	3	30
RI73N C8	8	415	3+N	786.091.262	411	3	30
RI73N C10	10	415	3+N	786.091.263	411	3	30
RI73N C13	13	415	3+N	786.091.264	411	3	30
RI73N C16	16	415	3+N	786.091.265	411	3	30
RI73N C20	20	415	3+N	786.091.266	414	3	30
RI73N C25	25	415	3+N	786.091.267	414	3	30
RI73N C32	32	415	3+N	786.091.268	414	3	30
RI73N C40	40	415	3+N	786.091.269	429	3	30
RI73N C50	50	415	3+N	786.091.270	466	3	30
RI73N C63	63	415	3+N	786.091.271	466	3	30



RI70 — B characteristics

Type	Rated Current I_n (A)	Rated Voltage U_n (V)	No. of Poles	Ordering No.	Weight (g)	Quantity / Box	Quantity / CTN
RI71							
RI71 B0.5	0.5	230/240	1	786.091.495	100	12	120
RI71 B1	1	230/240	1	786.091.272	105	12	120
RI71 B2	2	230/240	1	786.091.273	102	12	120
RI71 B3	3	230/240	1	786.091.274	104	12	120
RI71 B4	4	230/240	1	786.091.275	104	12	120
RI71 B6	6	230/240	1	786.091.276	104	12	120
RI71 B8	8	230/240	1	786.091.277	105	12	120
RI71 B10	10	230/240	1	786.091.278	105	12	120
RI71 B13	13	230/240	1	786.091.279	104	12	120
RI71 B16	16	230/240	1	786.091.280	104	12	120
RI71 B20	20	230/240	1	786.091.281	105	12	120
RI71 B25	25	230/240	1	786.091.282	105	12	120
RI71 B32	32	230/240	1	786.091.283	105	12	120
RI71 B40	40	230/240	1	786.091.284	110	12	120
RI71 B50	50	230/240	1	786.091.285	117	12	120
RI71 B63	63	230/240	1	786.091.286	123	12	120
RI72							
RI72 B0.5	0.5	415	2	786.091.484	200	6	60
RI72 B1	1	415	2	786.091.287	210	6	60
RI72 B2	2	415	2	786.091.288	220	6	60
RI72 B3	3	415	2	786.091.289	220	6	60
RI72 B4	4	415	2	786.091.290	220	6	60
RI72 B6	6	415	2	786.091.291	225	6	60
RI72 B8	8	415	2	786.091.292	226	6	60
RI72 B10	10	415	2	786.091.293	226	6	60
RI72 B13	13	415	2	786.091.294	226	6	60
RI72 B16	16	415	2	786.091.295	225	6	60
RI72 B20	20	415	2	786.091.296	226	6	60
RI72 B25	25	415	2	786.091.297	226	6	60
RI72 B32	32	415	2	786.091.298	226	6	60
RI72 B40	40	415	2	786.091.299	235	6	60
RI72 B50	50	415	2	786.091.300	235	6	60
RI72 B63	63	415	2	786.091.301	246	6	60
RI73							
RI73 B0.5	0.5	415	2	786.091.496	300	4	40
RI73 B1	1	415	3	786.091.302	315	4	40
RI73 B2	2	415	3	786.091.303	306	4	40
RI73 B3	3	415	3	786.091.304	312	4	40
RI73 B4	4	415	3	786.091.305	312	4	40
RI73 B6	6	415	3	786.091.306	312	4	40
RI73 B8	8	415	3	786.091.307	312	4	40
RI73 B10	10	415	3	786.091.308	312	4	40
RI73 B13	13	415	3	786.091.309	312	4	40
RI73 B16	16	415	3	786.091.310	312	4	40
RI73 B20	20	415	3	786.091.311	315	4	40
RI73 B25	25	415	3	786.091.312	315	4	40
RI73 B32	32	415	3	786.091.313	315	4	40
RI73 B40	40	415	3	786.091.314	330	4	40
RI73 B50	50	415	3	786.091.315	351	4	40
RI73 B63	63	415	3	786.091.316	367	4	40



RI70 — B characteristics

Type	Rated Current I_n (A)	Rated Voltage U_n (V)	No. of Poles	Ordering No.	Weight (g)	Quantity / Box	Quantity / CTN
RI74							
RI74 B0.5	0.5	415	4	786.091.497	400	3	30
RI74 B1	1	415	4	786.091.317	420	3	30
RI74 B2	2	415	4	786.091.318	424	3	30
RI74 B3	3	415	4	786.091.319	432	3	30
RI74 B4	4	415	4	786.091.320	432	3	30
RI74 B6	6	415	4	786.091.321	432	3	30
RI74 B8	8	415	4	786.091.322	432	3	30
RI74 B10	10	415	4	786.091.323	432	3	30
RI74 B13	13	415	4	786.091.324	432	3	30
RI74 B16	16	415	4	786.091.325	448	3	30
RI74 B20	20	415	4	786.091.326	448	3	30
RI74 B25	25	415	4	786.091.327	448	3	30
RI74 B32	32	415	4	786.091.328	447	3	30
RI74 B40	40	415	4	786.091.329	448	3	30
RI74 B50	50	415	4	786.091.330	468	3	30
RI74 B63	63	415	4	786.091.331	489	3	30
RI71N							
RI71N B0.5	0.5	230/240	1+N	786.091.501	199	6	60
RI71N B1	1	230/240	1+N	786.091.332	204	6	60
RI71N B2	2	230/240	1+N	786.091.333	201	6	60
RI71N B3	3	230/240	1+N	786.091.334	203	6	60
RI71N B4	4	230/240	1+N	786.091.335	203	6	60
RI71N B6	6	230/240	1+N	786.091.336	203	6	60
RI71N B8	8	230/240	1+N	786.091.337	204	6	60
RI71N B10	10	230/240	1+N	786.091.338	204	6	60
RI71N B13	13	230/240	1+N	786.091.339	203	6	60
RI71N B16	16	230/240	1+N	786.091.340	203	6	60
RI71N B20	20	230/240	1+N	786.091.341	204	6	60
RI71N B25	25	230/240	1+N	786.091.342	204	6	60
RI71N B32	32	230/240	1+N	786.091.343	204	6	60
RI71N B40	40	230/240	1+N	786.091.344	209	6	60
RI71N B50	50	230/240	1+N	786.091.345	216	6	60
RI71N B63	63	230/240	1+N	786.091.346	222	6	60
RI73N							
RI73N B0.5	0.5	415	3+N	786.091.503	400	3	30
RI73N B1	1	415	3+N	786.091.347	414	3	30
RI73N B2	2	415	3+N	786.091.348	405	3	30
RI73N B3	3	415	3+N	786.091.349	411	3	30
RI73N B4	4	415	3+N	786.091.350	411	3	30
RI73N B6	6	415	3+N	786.091.351	411	3	30
RI73N B8	8	415	3+N	786.091.352	411	3	30
RI73N B10	10	415	3+N	786.091.353	411	3	30
RI73N B13	13	415	3+N	786.091.354	411	3	30
RI73N B16	16	415	3+N	786.091.355	411	3	30
RI73N B20	20	415	3+N	786.091.356	414	3	30
RI73N B25	25	415	3+N	786.091.357	414	3	30
RI73N B32	32	415	3+N	786.091.358	414	3	30
RI73N B40	40	415	3+N	786.091.359	429	3	30
RI73N B50	50	415	3+N	786.091.360	466	3	30
RI73N B63	63	415	3+N	786.091.361	466	3	30



RI70 — D characteristics

Type	Rated Current I_n (A)	Rated Voltage U_n (V)	No. of Poles	Ordering No.	Weight (g)	Quantity / Box	Quantity / CTN
RI71							
RI71 D0.5	0.5	230/240	1	786.091.482	100	12	120
RI71 D1	1	230/240	1	786.091.362	105	12	120
RI71 D2	2	230/240	1	786.091.363	102	12	120
RI71 D3	3	230/240	1	786.091.364	104	12	120
RI71 D4	4	230/240	1	786.091.365	104	12	120
RI71 D6	6	230/240	1	786.091.366	104	12	120
RI71 D8	8	230/240	1	786.091.367	105	12	120
RI71 D10	10	230/240	1	786.091.368	105	12	120
RI71 D13	13	230/240	1	786.091.369	104	12	120
RI71 D16	16	230/240	1	786.091.370	104	12	120
RI71 D20	20	230/240	1	786.091.371	105	12	120
RI71 D25	25	230/240	1	786.091.372	105	12	120
RI71 D32	32	230/240	1	786.091.373	105	12	120
RI71 D40	40	230/240	1	786.091.374	110	12	120
RI71 D50	50	230/240	1	786.091.375	117	12	120
RI71 D63	63	230/240	1	786.091.376	123	12	120
RI72							
RI72 D0.5	0.5	415	2	786.091.484	200	6	60
RI72 D1	1	415	2	786.091.377	210	6	60
RI72 D2	2	415	2	786.091.378	220	6	60
RI72 D3	3	415	2	786.091.379	220	6	60
RI72 D4	4	415	2	786.091.380	220	6	60
RI72 D6	6	415	2	786.091.381	225	6	60
RI72 D8	8	415	2	786.091.382	226	6	60
RI72 D10	10	415	2	786.091.383	226	6	60
RI72 D13	13	415	2	786.091.384	226	6	60
RI72 D16	16	415	2	786.091.385	225	6	60
RI72 D20	20	415	2	786.091.386	226	6	60
RI72 D25	25	415	2	786.091.387	226	6	60
RI72 D32	32	415	2	786.091.388	226	6	60
RI72 D40	40	415	2	786.091.389	235	6	60
RI72 D50	50	415	2	786.091.390	235	6	60
RI72 D63	63	415	2	786.091.391	246	6	60
RI73							
RI73 D0.5	0.5	415	3	786.091.498	300	4	40
RI73 D1	1	415	3	786.091.392	315	4	40
RI73 D2	2	415	3	786.091.393	306	4	40
RI73 D3	3	415	3	786.091.394	312	4	40
RI73 D4	4	415	3	786.091.395	312	4	40
RI73 D6	6	415	3	786.091.396	312	4	40
RI73 D8	8	415	3	786.091.397	312	4	40
RI73 D10	10	415	3	786.091.398	312	4	40
RI73 D13	13	415	3	786.091.399	312	4	40
RI73 D16	16	415	3	786.091.400	312	4	40
RI73 D20	20	415	3	786.091.401	315	4	40
RI73 D25	25	415	3	786.091.402	315	4	40
RI73 D32	32	415	3	786.091.403	315	4	40
RI73 D40	40	415	3	786.091.404	330	4	40
RI73 D50	50	415	3	786.091.405	351	4	40
RI73 D63	63	415	3	786.091.406	367	4	40



RI70 — D characteristics

Type	Rated Current I_n (A)	Rated Voltage U_n (V)	No. of Poles	Ordering No.	Weight (g)	Quantity / Box	Quantity / CTN
RI74							
RI74 D0.5	0.5	415	4	786.091.499	400	3	30
RI74 D1	1	415	4	786.091.407	420	3	30
RI74 D2	2	415	4	786.091.408	424	3	30
RI74 D3	3	415	4	786.091.409	432	3	30
RI74 D4	4	415	4	786.091.410	432	3	30
RI74 D6	6	415	4	786.091.411	432	3	30
RI74 D8	8	415	4	786.091.412	432	3	30
RI74 D10	10	415	4	786.091.413	432	3	30
RI74 D13	13	415	4	786.091.414	432	3	30
RI74 D16	16	415	4	786.091.415	448	3	30
RI74 D20	20	415	4	786.091.416	448	3	30
RI74 D25	25	415	4	786.091.417	448	3	30
RI74 D32	32	415	4	786.091.418	447	3	30
RI74 D40	40	415	4	786.091.419	448	3	30
RI74 D50	50	415	4	786.091.420	468	3	30
RI74 D63	63	415	4	786.091.421	489	3	30



Dimensions

(mm)

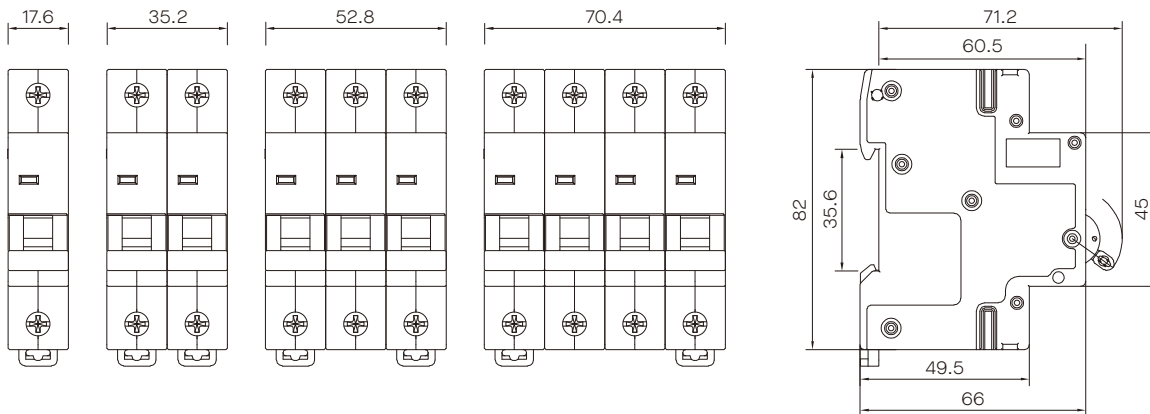

Wiring diagram

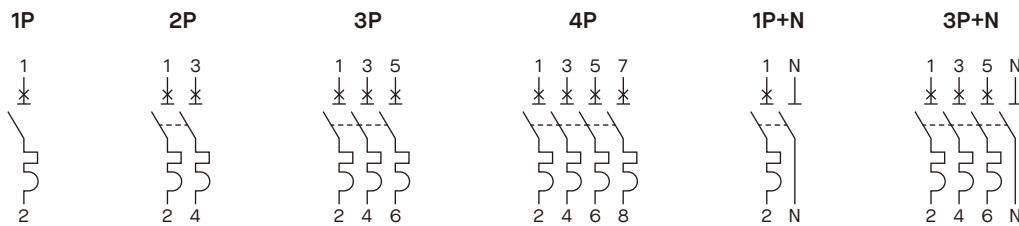

RI70J | DC

Miniature Circuit Breakers

Types

- RI71J single pole
- RI72J two pole
- RI73J three pole
- RI74J four pole

Benefits

- ▶ Used as DC protection for switchboards in PV systems
- ▶ Supports maximum system voltage up to 1200 VDC
- ▶ Short circuit, overload and surge protection



Technical data	Symbol	Unit	RI70J			
Standards			IEC/EN 60947-2			
Rated current	I_n	A	1, 2, 3, 4, 6, 10, 16, 20, 25, 32, 40, 50, 63			
Number of poles			1P	2P	3P	4P
Voltage	U_i	V	220/250	440/500	660/750	880/1000
Rated short-time making capacity (I _{cm}) – 6 kA		VDC	500	600	1500	1500
Rated short-time making capacity (I _{cm}) – 10 kA		VDC	300	600	1200	1200
Tripping characteristics			C			
Tripping type			thermal magnetic			
Rated impulse withstand voltage	U_{imp}	kV	6			
Electrical endurance			3000 cycles			
Mechanical endurance			10000 cycles			
Ambient temperature		°C	-20 ... +70			
IP degree			IP20			

RI70J – C characteristics

Type	Rated Current I_n (A)	Voltage U_i (V)	Number of Poles	Ordering No.	Weight (g)	Quantity / Box	Quantity / CTN
RI71J							
RI71J C1	1	220/250	1	786.091.422	121	12	120
RI71J C2	2	220/250	1	786.091.423	121	12	120
RI71J C3	3	220/250	1	786.091.424	121	12	120
RI71J C4	4	220/250	1	786.091.425	121	12	120
RI71J C6	6	220/250	1	786.091.426	118	12	120
RI71J C10	10	220/250	1	786.091.428	118	12	120
RI71J C16	16	220/250	1	786.091.430	118	12	120
RI71J C20	20	220/250	1	786.091.431	118	12	120
RI71J C25	25	220/250	1	786.091.432	118	12	120
RI71J C32	32	220/250	1	786.091.433	118	12	120
RI71J C40	40	220/250	1	786.091.434	118	12	120
RI71J C50	50	220/250	1	786.091.435	121	12	120
RI71J C63	63	220/250	1	786.091.436	121	12	120
RI72J							
RI72J C1	1	440/500	2	786.091.437	242	6	60
RI72J C2	2	440/500	2	786.091.438	242	6	60
RI72J C3	3	440/500	2	786.091.439	242	6	60
RI72J C4	4	440/500	2	786.091.440	242	6	60
RI72J C6	6	440/500	2	786.091.441	236	6	60
RI72J C10	10	440/500	2	786.091.443	236	6	60
RI72J C16	16	440/500	2	786.091.445	236	6	60
RI72J C20	20	440/500	2	786.091.446	236	6	60
RI72J C25	25	440/500	2	786.091.447	236	6	60
RI72J C32	32	440/500	2	786.091.448	236	6	60
RI72J C40	40	440/500	2	786.091.449	236	6	60
RI72J C50	50	440/500	2	786.091.450	242	6	60
RI72J C63	63	440/500	2	786.091.451	242	6	60
RI73J							
RI73J C1	1	660/750	3	786.091.452	362	4	40
RI73J C2	2	660/750	3	786.091.453	362	4	40
RI73J C3	3	660/750	3	786.091.454	362	4	40
RI73J C4	4	660/750	3	786.091.455	362	4	40
RI73J C6	6	660/750	3	786.091.456	354	4	40
RI73J C10	10	660/750	3	786.091.458	354	4	40
RI73J C16	16	660/750	3	786.091.460	354	4	40
RI73J C20	20	660/750	3	786.091.461	354	4	40
RI73J C25	25	660/750	3	786.091.462	354	4	40
RI73J C32	32	660/750	3	786.091.463	354	4	40
RI73J C40	40	660/750	3	786.091.464	354	4	40
RI73J C50	50	660/750	3	786.091.465	484	4	40
RI73J C63	63	660/750	3	786.091.466	484	4	40



RI70J – C characteristics

Type	Rated Current I_n (A)	Voltage U_i (V)	Number of Poles	Ordering No.	Weight (g)	Quantity / Box	Quantity / CTN
RI74J							
RI74J C1	1	880/1000	4	786.091.467	482	3	30
RI74J C2	2	880/1000	4	786.091.468	482	3	30
RI74J C3	3	880/1000	4	786.091.469	482	3	30
RI74J C4	4	880/1000	4	786.091.470	482	3	30
RI74J C6	6	880/1000	4	786.091.471	468	3	30
RI74J C10	10	880/1000	4	786.091.473	468	3	30
RI74J C16	16	880/1000	4	786.091.475	468	3	30
RI74J C20	20	880/1000	4	786.091.476	468	3	30
RI74J C25	25	880/1000	4	786.091.477	468	3	30
RI74J C32	32	880/1000	4	786.091.478	468	3	30
RI74J C40	40	880/1000	4	786.091.479	468	3	30
RI74J C50	50	880/1000	4	786.091.480	482	3	30
RI74J C63	63	880/1000	4	786.091.481	482	3	30



Dimensions

(mm)

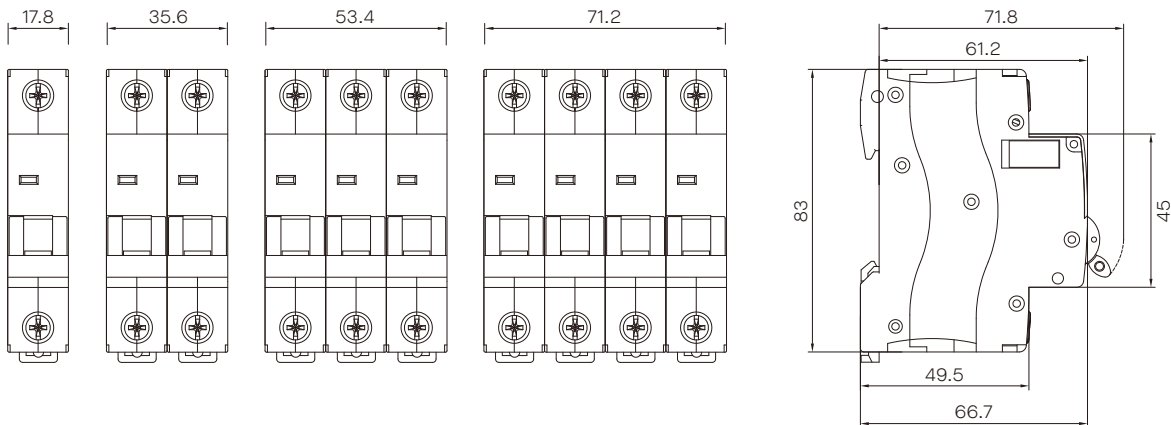

Wiring diagram

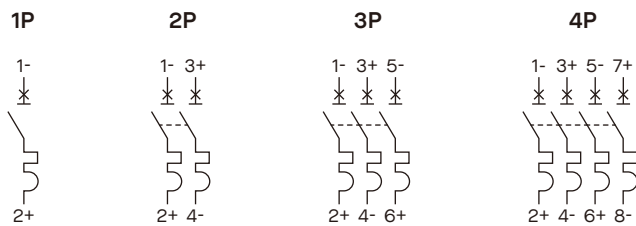

Accessories for RI70

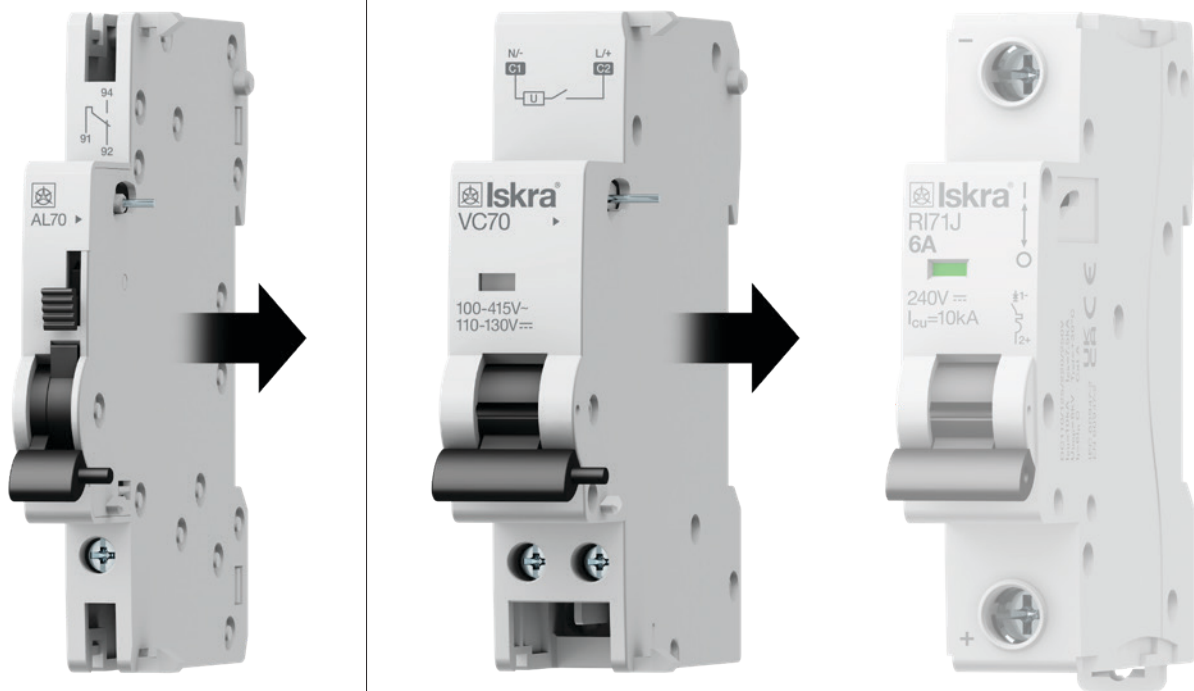

Types

- PS70-11 auxiliary contact
- AL70 alarm switch
- VC70 shunt release
- PC70 overvoltage and under-voltage release

PS70-11
Auxiliary Contact



AL70
Alarm Switch



Model	Symbol	Unit	Data
Rated current	I_n	A	3 A (400 VAC) 6 A (240 VAC) 1 A (110 VDC)
Terminal		mm ²	0.5 - 4
Dielectric strength		V/1min	2000
Electro-mechanical endurance			≥ 5000 times
Ordering No.			786.091.488
Quantity / Box			10/100

Model	Symbol	Unit	Data
Contact capacity	I_n	A	3 A (400VAC) 6 A (230VAC) 9 A (125VDC)
Rated power voltage	U_s	V	400, 230, 125
Operating voltage range	U_s		70 - 100 %
Dielectric strength		V/1min	2000
Rated insulating voltage	U_i	V	500
Electro-mechanical endurance			≥ 4000 times
Ordering No.			786.091.489
Quantity / Box			10/100

Dimensions
(mm)

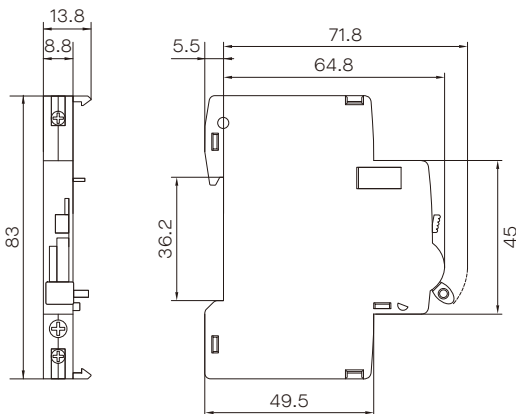

VC70
Shunt Release



PC70
Overvoltage and
undervoltage release



Model	Symbol	Unit	Data
Nominal voltage	U_s	VAC	110 ~ 415
Max inrush current	I_n		3 A (415 VAC)
			6 A (230 VAC)
			9 A (110 VAC)
Dielectric strength		V/1min	2000
Release range		VAC	110 ~ 415
Electro-mechanical endurance			≥ 4000 times
Ordering No.			786.091.490
Quantity / Box			10/100

Model	Symbol	Unit	Data
Rated voltage	U_n	VAC	230
Max tripping voltage		V	280
Min tripping voltage		VAC	170
Electro-mechanical endurance			≥ 4000 times
Ordering No.			786.091.491
Quantity / Box			10/100

Dimensions
(mm)

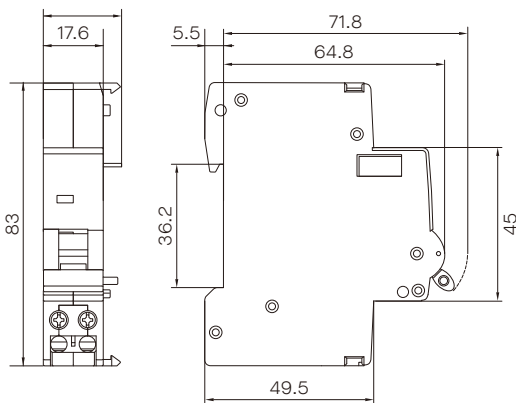

RI100 10 kA

Miniature Circuit Breakers

Types

- RI 101 single-pole
- RI 101N single pole + neutral pole
- RI 102 two-pole
- RI 103 three-pole
- RI 103N three-pole + neutral pole
- RI 104 four pole



Applications

Miniature circuit breakers of RI100 series are used for switching, conducting and switching-off the current not only in normal operating conditions but also in special conditions in a circuit such as short circuit. They are used for overcurrent protection of house installations, industrial electric distributions and devices.

Benefits

- ▶ High rated short-circuit breaking capacity up to 10 kA on IEC 60947-2/ IEC 60898-1 standard
- ▶ Service life of product has been greatly enhanced through special designed tripping mechanism
- ▶ Long-time and reliable operation
- ▶ Enclosure and functional parts made from imported plastics with flame-retardant, heat-resistant, and impulse-proof properties
- ▶ Compact and modularized design
- ▶ Convenient mounting

Standards

- ▶ IEC/EN 60947-2

RI100 characteristics

Technical data	Symbol	Unit	RI100
Area of use			AC systems
Standards			IEC/EN 60947-2
Approvals			SEMKO, CE
Number of poles			1,1+N, 2, 3, 3+N, 4
Tripping characteristics			C
Rated currents	I_n	A	80, 100, 125
Rated voltage	U_n	V	230, 230/400, 400
Rated DC voltage	U_n	V	max. 60
Max. time constant for DC voltage	t	ms	3
Rated impulse withstand voltage	U_{imp}	kV	4
Rated insulation voltage	U_i	V	690
Rated frequency	f	Hz	50/60
Rated short-circuit breaking capacity	$I_{cu} I_{cn}$	kA	10
Service short-circuit breaking capacity	I_{cs}	kA	7.5
Selectivity class			3
Electrical endurance		op. c.	4 000
Mechanical endurance		op. c.	10 000
Terminal capacity			1 ... 50
Screw type			M5
Screw head			PZ2
Tightening torque		Nm	3.5
Mounting			35 mm DIN rail acc. to 60715, with clip on panel
Degree of protection	front panel		IP40
	housing		IP20
Ambient temperature		°C	-10 ... +50
Altitude*		m	up to 2000
Mounting position			any
Resistance against vibrations			3 g (8 ... 50 Hz)

* Above max. altitude the voltages U and U are reduced by 1.2%, i.e. nominal rating I is reduced by 0.4% for every additional 100 m

RI100 – B characteristics

Type	Rated Current I_n (A)	Rated Voltage U_n (V)	Number of Poles	Ordering No.	Weight (g)	Packaging (pcs)
RI101						
RI101 B80	80	230	1	786.101.220	160	12
RI101 B100	100	230	1	786.101.221	160	12
RI101 B125	125	230	1	786.101.222	160	12
RI102						
RI102 B80	80	230/400	2	786.101.226	320	6
RI102 B100	100	230/400	2	786.101.227	320	6
RI102 B125	125	230/400	2	786.101.228	320	6
RI103						
RI103 B80	80	400	3	786.101.229	490	4
RI103 B100	100	400	3	786.101.230	490	4
RI103 B125	125	400	3	786.101.231	490	4
RI104						
RI104 B80	80	400	4	786.101.235	640	3
RI104 B100	100	400	4	786.101.236	640	3
RI104 B125	125	400	4	786.101.237	640	3



RI100 – C characteristics

Type	Rated Current I_n (A)	Rated Voltage U_n (V)	Number of Poles	Ordering No.	Weight (g)	Packaging (pcs)
RI101						
RI101 C80	80	230	1	786.101.250	160	12
RI101 C100	100	230	1	786.101.251	160	12
RI101 C125	125	230	1	786.101.252	160	12
RI102						
RI102 C80	80	230/400	2	786.101.256	320	6
RI102 C100	100	230/400	2	786.101.257	320	6
RI102 C125	125	230/400	2	786.101.258	320	6
RI103						
RI103 C80	80	400	3	786.101.259	490	4
RI103 C100	100	400	3	786.101.260	490	4
RI103 C125	125	400	3	786.101.261	490	4
RI104						
RI104 C80	80	400	4	786.101.265	640	3
RI104 C100	100	400	4	786.101.266	640	3
RI104 C125	125	400	4	786.101.267	640	3

Tripping characteristics

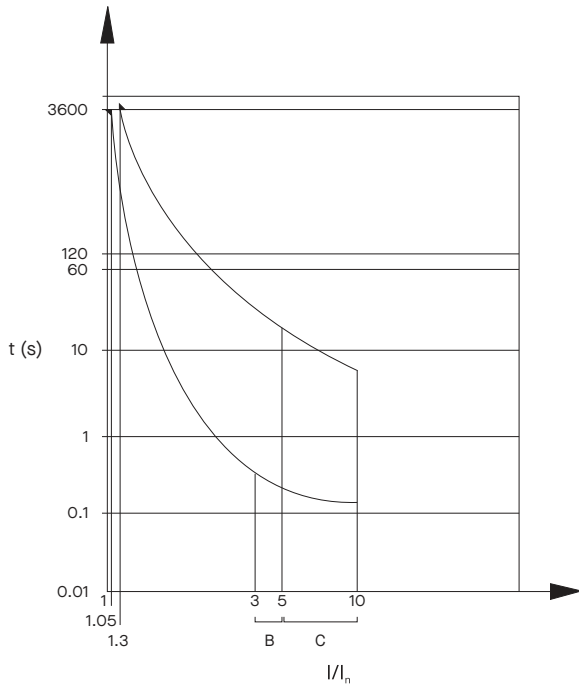

B type

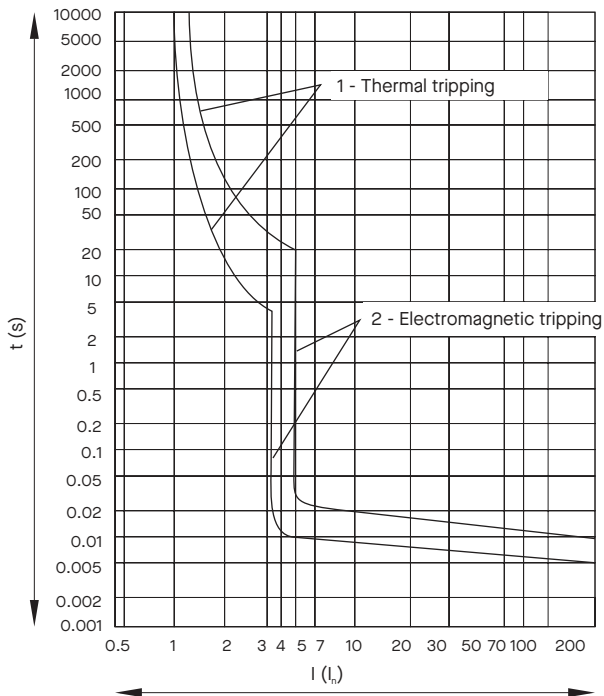

C type

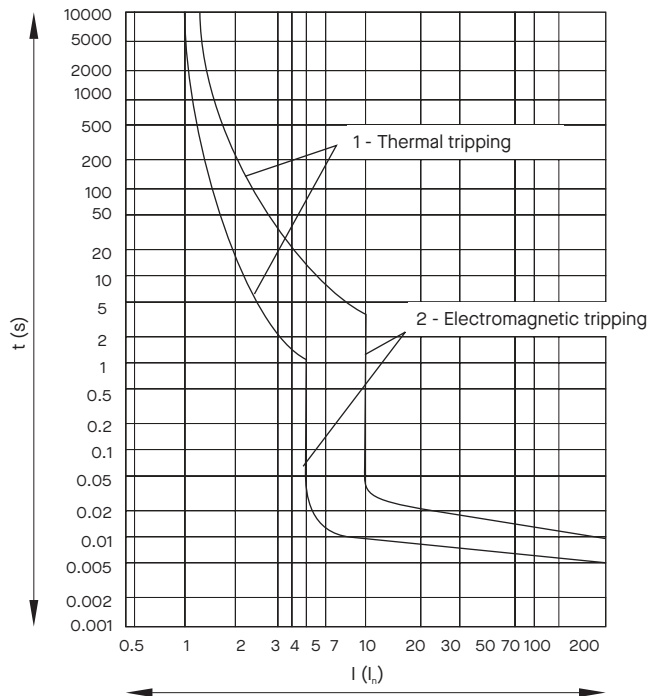

Dimensions

(mm)

R1101

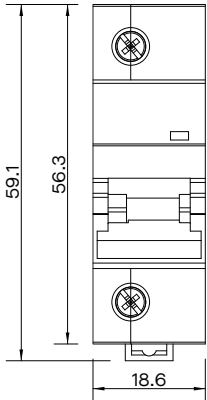

R1102
R1102+N

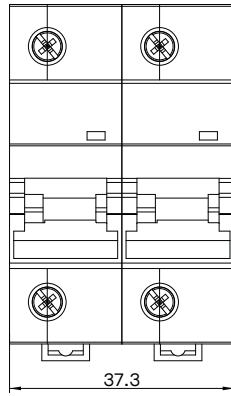

R1103

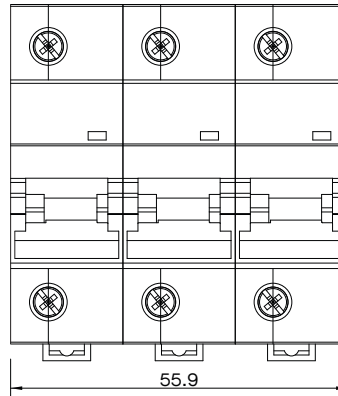

R1103 +N
R1104

